



**2023 Membership Packet**

**Sierra Nevada Junior Rodeo  
and Gymkhana, Inc.**

## INDEX

2023 SNGC GYMKHANA SCHEDULE + Monthly Revolving “Event” .....	pg 2
2023 Officers & Director.....	pg 3
Age Groups .....	pg 3
Point Events.....	pg 3
Non-Point Events.....	pg 3
Membership Overview.....	pg 4
Committees Overview.....	pg 5-6
Volunteer Events/Fundraising Overview .....	pg 6-7
Rules.....	pg 8-16
General rules.....	pg 8-12
Points.....	pg 13-14
Age Divisions.....	pg 14
Awards.....	pg 14-15
Classes.....	pg 15
Goats.....	pg 15-16
Patterns.....	pg 17-26
Checklist for forms to be turned in.....	pg 27
Membership.....	pg 28-29
Individual & Non-competing.....	pg 28
Family.....	pg 29
Assumption of Risk, Liability and Indemnification Agreement.....	pg 30-31
Release.....	pg 32
Rules Received.....	pg 33
Raffle Ticket Sales.....	pg 34
Plaque Order Form.....	pg 35
Volunteer/Committee Form.....	pg 36

# **2023 SNJR/SNGC Membership Packet**

If you ride as a Non-Member, you will not be eligible or begin accumulating YEAR-END POINTS until you change your status to a Member by paying in full the membership fee. You will however be eligible for day-end points and awards.

## **2023 SNGC GYMKHANA SCHEDULE + Monthly Revolving “Event”**

**Saturday April 22nd Annual Gandolfo Arena Workday**

**Sunday April 23rd Playday and Queen Contest**

**Saturday May 6th Gymkhana #1 “Two Barrel Cow Horse”**

**Sunday May 14th Gymkhana #2 “Big M”**

**Sunday June 11th Gymkhana #3 “Turn and Burn”**

**Saturday August 5th Junior Rodeo**

**\*Sunday August 6th Open day for an event of choice if no 2nd day of Jr Rodeo\***

**Saturday August 12th Gymkhana #4 – Big T**

**Sunday September 10th Gymkhana #5 – Speed Barrels**

**Saturday September 23rd Gymkhana #6 – Single Stake**

**Sunday October 15th – Make-up / Halloween Event**

All Gymkhanas start at 9am – Summer months may begin 1hr early due to afternoon heat.

**Pre-entry is required and the details will be provided to you for pre-entry on our website.**

For questions email [snjrandsngc@gmail.com](mailto:snjrandsngc@gmail.com)

## **AGE GROUPS**

### **AGE DETERMINED AS OF FIRST GYMKHANA OF THE YEAR (May 6th)**

0-7 \* 8 -10 \* 11-13 \* 14-18 \* 19 & Over

## **POINT EVENTS**

BARRELS, POLES, BI-RANGLE, FIGURE 8, REVOLVING.

## **NON-POINT EVENTS**

Goat un-decorating & Goat tying

## **GENERAL INFORMATION**

Memberships are good for one year (Memberships start on the 3rd week of January and end the following 3rd week of January).

Monthly meetings are held on the second Thursday of each month. Currently meetings are held at Blind Onion, 295 Los Altos Pkwy, Sparks. A meeting location can change due to certain circumstances. Changes will be announced ahead of time to all. They will begin promptly at 6:00 pm. Your opinions, suggestions and comments are important. Please make it a point to attend the monthly meetings.

### **2023 Officers**

Jayson Hill, President  
Kim Eastman, Vice President  
Marcie Miller, Secretary  
Abbie Shelton, Treasurer  
Amy Nesler, Treasurer

### **2023 Directors**

Kathy Trute	Brystin Vierra
Lisa Jones	Janet Bierman
Joylene Hill	Dale Miller
Mark Scott	Nicole Vierra
Deb Foley	Allison Galloway

## **MEMBERSHIP 2023**

The Sierra Nevada Junior Rodeo and Gymkhana Club  
Offer (6) Different Types of Memberships.

***Minor children must have a family membership.***

### **General Individual Membership- \$75 Must be 18-years or older.**

This type of membership is for one individual who is 18 years of age (as of the first gymkhana) or older and will be participating. This membership requires a **mandatory** amount of volunteer/fundraising duties for the Junior Rodeo/Gymkhana season. See "Volunteer/Fundraising" portion of this membership package for details. Points will begin to accumulate after the membership fee is paid. This membership has the right to vote.

### **General Family Membership - \$150.00**

*(Family means IMMEDIATE family in the same current household. If the child is 18 or older but still in school, he or she is covered under this Family membership.)* This membership requires a **mandatory** amount of volunteer/fundraising duties for the Junior Rodeo/Gymkhana season. See "Volunteer/Fundraising" portion of this membership package for details. Points will begin to accumulate after the membership fee is paid. This membership has the right to vote.

### **General Family (1) Child (1) Non-Competing Membership - \$125.00**

*(Family means IMMEDIATE family in the same current household. If the child is 18 or older but still in school, he or she is covered under this Family membership.)* This membership is for single families with one competing child. This membership requires a **mandatory** amount of volunteer/fundraising duties for the Junior Rodeo/Gymkhana season. See "Volunteer/Fundraising" portion of this membership package for details. Points will begin to accumulate after the membership fee is paid. This membership has the right to vote.

### **Associate Individual Membership - \$350**

This type of membership is for one individual who is **18**-years of age (as of the first gymkhana) or older and will be participating and DOESN'T accumulate volunteer points. They **DO NOT** want to volunteer time at regular events. This membership gives up the right to vote.

### **Associate Family Membership - \$525**

*(Family means IMMEDIATE family in the same household. If the child is 18 or older but still in school, he or she is covered under this Family membership.)* This type of membership is for families. If two or more people in the family will be competing, and **DO NOT** want to volunteer any time this is the membership you would choose. This membership gives up the right to vote, however this membership still requires the members to participate in any outlined fundraising opportunities.

### **General Non-Competing Membership \$50**

This membership is for someone who would like to be a part of the club but does not compete. This membership requires a mandatory amount of volunteer/fundraising duties for the Junior Rodeo/Gymkhana season.

**This club relies on the support of its members. Volunteers run all aspects of this club. Though there are some special circumstances in which individuals/families are unable to volunteer, we urge you to consider the cost savings in your decision. Keep in mind, volunteer time is not just immediate family. Aunts, Uncles, Brothers, Sisters, Grandparents, Neighbors and Friends can perform volunteer time. (See Volunteer section for further explanation)**

## **\*\*Committees & Volunteering\*\***

Volunteers run SNGC and SNJR. We are a non-profit organization that relies on the help of its members and their families and friends. We rely on you, volunteers and all its members for success.

All memberships require participation on at least one and occasionally (multiple committees depending the amount of volunteer work required for each. These committees are chosen when you complete your membership packet. A primary, secondary and additional priority of committees will be chosen so we have an idea of your liking. The Director and Chair of the committee are responsible for ensuring that all members of the committee are fulfilling their obligations outlined within. Members not participating in their committees will receive one warning. If the member does not fulfill requested duties of the committee, the member will be considered a member in bad standing. A member in bad standing will make the member ineligible for end-of-the-year awards.

**Membership, Points, and Rules Committee-** This committee is responsible for tracking the membership status (including any members in bad standing), tracking the points, and ensuring that all rules are followed in line with our club rule book. This committee is also responsible for making sure points are updated and posted.

**Fundraising, Public Relations and Advertising Committee-** This committee is responsible for assisting with fundraising, coordinating with the Queen Committee, social media posting, and community involvement opportunities. (If part of this committee you also need to pick one additional committee to be part of).

**Equipment, Security and Grounds Committee-** This committee is responsible for the overall maintenance and groundwork for the event. This includes transport or coordination of equipment such as tractors and water trucks as well as preparation of the arenas.

**Events Committee-** This committee ensures that all utilities are opened/closed, cleaned, and stocked for all events. Members will be responsible for gymkhana events set up, and break down, as well as ensuring that all equipment is returned to the Conex at the end of the day. The Committee Chair is responsible for ensuring that all gates are manned during the event. Any equipment in need of repairs will be reported to the equipment, security and grounds committee.

**Awards/Prize/Banquet Committee-** This committee will be responsible for day end awards, junior rodeo awards and end of the year awards. This includes High Point and Reserve High Point at each event as well as coordinating any other prizes such as ribbons and plaque plates.

**Goat Committee-** This committee is responsible for sourcing goats for the gymkhanas and the junior rodeo, as well as ensuring that all the equipment is prepared and ready to go for each event (ribbons, stop watches, flags, rope, securing post). This committee will staff the arena during the goat events (goat holders, horse holder, assistance for smaller kids, timer and flagger).

**Food and Snack Bar Committee-** This committee is responsible for ensuring that refreshments are available at each event, such as BBQing, food truck or staffed snack bar. This committee is responsible for coordinating and presenting a budget to the board for approval. This committee is also responsible for ensuring that there are coolers of water or other refreshments available for purchase at each event.

**Queen/Flag Committee-** This committee is responsible for the queen contest, as well as ensuring that the queens are fulfilling their outlined obligations. This committee works alongside the fundraising and public relations committee to ensure community involvement. This includes special guest opportunities for the queens. This committee will also be responsible for the Grand Entry and making sure all flags are presentable and the people carrying flags are presentable. The only hat accepted while carrying the State or American flag will be the traditional western Cowboy/Cowgirl Hat.

**Jr Rodeo Committee-** All members are required to attend and help during the Sierra Nevada Junior Rodeo. The Jr. Rodeo Committee will work with the gymkhana committees to ensure all tasks are covered.

- Please remember that the hours for each committee will be tracked by the Director and Committee Chair to ensure that all members are fulfilling their volunteer obligations.

## **VOLUNTEER EVENTS/FUNDRAISING OVERVIEW**

SNJR & SNGC rely on fundraising to provide quality prizes at our Junior Rodeo and Year-End Awards Banquet. Potential fundraising opportunities include but are not limited to:

Raffle Ticket Sales  
Silent Auctions  
Raffle Donations  
Sponsors and Donors  
Jackpots  
Volunteering at other Rodeos or Events

**Sierra Nevada Jr. Rodeo:** Either one or two-day event. People needed: timers, gate people, set-up, tear down, point helpers, announcers, judges, flaggers, livestock, etc. For a full list and explanation of jobs, please contact any SNJR-SNGC Director.

**Reno Rodeo Program Sales:** When invited, this fundraiser brings in a lot of money for our year-end awards. We will need up to 30 people per night to help sell the programs (1 adult per 3-4 kids). This is a great family event to work. Volunteers can be needed as early as 5pm until last minute attendees come through the gates. Additional assistance is needed for stuffing programs before the event.

**Truckee Pro Rodeo:** The Truckee Pro Rodeo is an excellent opportunity for us to promote our club. We are assigned duties such as parking and food/drink sales in the box seat areas.

**Raffle ticket Sales:** The sale of the raffle tickets has historically been a successful fundraising event. The funds generated from these sales are used toward awards for the Junior Rodeo and Gymkhana end of year awards. Each non-competing member will be given 10 tickets to sell, individual members will be given 15 tickets to sell, and family memberships will be given 25 tickets to sell. The tickets will be distributed at the membership drive/ play day or at the first gymkhana of the season or just when a special opportunity might arise for our club. Additional tickets will be available upon request. Any unsold tickets and money must be turned in by the end of the sales event or when requested by a director.

**Note:** Any lost or unaccounted for tickets are the sole responsibility of the member or family they were assigned. A member will not be considered in good standing if there are unsold tickets and/or monies not returned. This will result in a review process by the board of directors. After review by the board, the decision will be emailed to the members involved.



# SNGC RULE BOOK



REVISED FOR 2023

## SIERRA NEVADA GYMKHANA RULES

1. SNGC events are open to all breeds, including mules and ponies.
2. To participate, the regular fees must be paid, and riders must follow SNGC rules. Anyone who is disruptive in any way must leave the arena without further refund of entry fees.
3. Officials and Directors, without exception or warning, have the right to disqualify or refuse entry to any contestant for any actions of misconduct including but not limited to any of the following:
  - i. Profanity or harassment of
    1. Judges
    2. Officials
    3. Members
  - ii. Outright poor sportsmanship
  - iii. Unruly or out of control animals
  - iv. Mistreatment or abuse to
    1. horse(s)
    2. Livestock
  - a. If any of the above occur at any of the following locations, you will receive one warning:
    - v. In club meetings
    - vi. On social media
    - vii. email communication
    - viii. any rude/disrespectful comments
    - ix. and/or unkind comments
  - b. If a second offense occurs,
    - i. the member(s) can be identified as a member(s) **not** in good standing.
    - ii. Spectators may be ejected from the grounds.
    - iii. Intoxicated contestants will be disqualified.
    - iv. If a member is disqualified based on any of the above entry fees will not be refunded.
4. Anyone who bounces a check will have to pay cash to cover the check plus any returned item fees before he/she will be allowed to compete and earn further points. For the rest of the season, he/she will have to pay in cash only. Any accounts not in good standing will forfeit year end points and awards will be void.
5. No lame horse will be permitted to compete under any circumstance. Any Director or Official who observes a lame horse should advise the competitor of such.
6. If a contestant's horse is injured, or becomes lame over the course of the event, the rider can voluntarily withdraw the horse from the remaining events and or choose to run a

backup horse to receive further points in the remaining events. If a backup horse is chosen a minimum of three Directors will be called to evaluate the situation and confirm the need for a backup point horse in order to continue the day's events. If a backup horse is not chosen, a refund can be requested for the following remaining event fees and only the accumulated points will stand.

7. Should the competitor disagree with the official about suspected lameness or injury to a horse, a minimum of three Directors will be called to observe the suspected lameness or injury. The competitor must submit the horse for examination by moving the horse to a trot, if necessary, to determine whether the horse is suspected to be lame or injured. Refusal to comply shall result in immediate disqualification for the day. If the three directors agree that the horse is suspected to be lame or injured, the horse will be disqualified for the day. An option to ride a backup horse will be given if one is readily available for the remaining events to accumulate points on.
8. If a horse has visible signs of illness, for example lacerations, runny nose, saliva from mouth or any other visible signs of illness or injury that could risk other equine; a minimum of three Directors will be called to observe the suspected horse and may ask that the horse be removed from the premises until it is vet checked or showing no signs of illness or injury.
9. Should a contestant disagree with the decision of the Directors, he/she may choose a licensed veterinarian, call him/her to the arena at his/her own expense. If the veterinarian(s) opinion is that the horse is sound and able to compete without drugs, the horse will be reinstated to the remaining events. Otherwise, the disqualification will stand.
10. Horse drugging to disguise lameness or to tranquilize is a violation of the horse-drugging act and is prohibited. Such an act will result in immediate disqualification and entry fees will not be refunded.
11. No form of excessive whipping or spurring or striking of the horse on the head will be allowed **PERIOD**. The rider or guest will be warned once, then disqualified for the rest of the day's events without refund if subsequent infraction occurs.
12. Horses entering the arena gate must be at a collected gait. The arena director has discretion as to if a contestant is purposely charging a gate or is out of control. This rule is not to be attempted to be enforced by contestants or spectators. If a contestant is found to be in violation of charging the gate, they will receive one warning. On the next occasion of the same offense, disqualification from that event will occur.
13. Stallions are allowed for senior riders only. Senior riders are those 18-years and older. Stallions must always be under control, inside and outside the arena. Any Stallion

felt to be jeopardizing the safety of others will be asked to leave without refund of entry fees. No mares with a foal at their side will be allowed to compete.

14. Horses may be ridden by multiple riders, if sharing the horse does not create delays in the event. Please use your best judgment. The point horse utilized must be declared by each rider during registration prior to that day's Gymkhana start. If there are concerns that a horse is being mistreated, a minimum of three Directors will be called to evaluate the concerns. If the Directors feel the concerns are valid, a vet note may be requested. (This rule gives family and friends with 1 horse the ability to participate with multiple riders without buying an additional horse.)
15. No running of horses will be allowed outside the arena, except in a designated warm up arena. Violators will receive one warning from an official. If he/she continues disobeying this rule, disqualification from the next class entered without refund of entry fees will result.
16. Horses must be kept away from the snack bar area; this is a health code violation. Repeated violation of this rule is also a reason for dismissal from the arena grounds.
17. Dogs must ALWAYS be on a leash and are not allowed to disrupt the Gymkhanas. All dogs will be restricted to the vehicle and the trailer area. If a dog becomes aggressive to a person or another animal, the owner will be asked to remove the dog from the grounds and will not be allowed to return.
18. Contestants must wear western boots, long pants, long sleeve, or short sleeve shirts. Tank-tops/crop tops will NOT be allowed in the arena.
19. Any appropriate, humane western equipment may be used. Equipment must be of normal construction and in good repair.. Normal stirrup leathers must be present, of usable length and not tied. Tie down is optional. Unusual construction or arrangements may result in disqualification of the rider if considered by Gymkhana officials to be inhumane, abnormal, or dangerous.
20. Any contestant can protest any infraction or decision. Contestants under 18-years of age must have a parent or guardian present at the time of protest. Protests must be done prior to the next event, or at the majority of the director's discretion.
21. The course must be run in accordance with the prescribed pattern or disqualification will occur.
  - a. This includes the break of forward motion; this is not the same as breaking a pattern.
22. No open containers of alcohol allowed at gates or in the arena.

23. For Age Group 0-7, a horse is on course when any part of the horse crosses the start/finish line. If a rider goes off course, but corrects the course, and completes the prescribed pattern, without re-crossing the timing line until the course is completed there will be no disqualification or penalty. Loss of forward motion will not be a penalty for the 0-7 age group.
24. 0-7 Lead liners will be part of the 0-7 group. However, certain added rules will apply as follows:
- a. If a rider is assisted by a handler, that handler may lead the rider through the course on foot at a WALK OR TROT ONLY.
  - b. The handler must be at the horse's shoulder when passing through the timing line. Handlers must be 18 or over in age. 60 seconds will be added to all lead line times.
  - c. Definition of "Assisted" shall be any contestant that is escorted, led, walked next to or held by a handler that crosses the start finish line.
25. Definition of "Independent", a rider that crosses the start finish line on their own and completes the pattern without the assistance of a handler. Riders may have an adult in the arena, but adults may NOT cross the start/finish line or contestants will be considered an "assisted" lead-liner and shall be scored as such. If your child signs up at the beginning of the year as a lead-liner he/she may advance to riding unassisted and all points accumulated as a lead-liner will remain with the rider and vice versa.
26. All 0-7 independent riders will be pointed above assisted riders until such a time they are unassisted.
27. Loss of control of animals will result in disqualification. Falling off horse while on course will result in disqualification. Unruly horse: the rider must be in control of the horse at all times, if the opinion of the official has determined, the safety of the rider or others might be in jeopardy, the contestant will be given one warning then upon second occurrence will be disqualified.
28. Knocking down or touching obstacles: Knocking down any obstacle (barrels, pole, etc.) shall result in a five (5) second penalty for each obstacle, however, touching an obstacle with the intent of keeping it from going down will not result in a penalty.
29. Failure to complete course: A contestant shall be disqualified if problems resulting from loss or breakage of equipment or tack prevents completion of the course.
30. A minimum of two stopwatches or an electronic timer will be used. If stopwatches are used, the times will be averaged.

31. Contestants must enter the arena gate within a reasonable amount of time. The arena director has the authority to move the rider to the end of the age division for that event for a second attempt to successfully enter the arena. If they are unable, they will be disqualified. If there is a legitimate reason (for example breakage of tack, conflict with arenas) for not being at the gate within one minute it must be brought to the attention of a grounds committee member or the arena director.
32. All contestants must be mounted when entering the arena gate for their call. Riders shall not mount their horses inside the arena. If it becomes a safety issue the arena director may allow the rider to walk in the arena and mount their horse or enter from an alternative gate. Any helper leading a rider on horseback into the arena, or otherwise assisting a contestant into the arena must leave the arena before the run begins.
33. Re-runs will not be given for breakage of tack or gear for any accident of horse or rider. In case of administrative error, reruns will be authorized.

## **POINTS**

1. Classes are open to anyone, but only members will receive SNGC points towards year-end awards. Points will begin to accumulate upon payment of dues, and they are not retroactive. A new membership application must be filled out and paid each year.
2. Each rider must declare their point horse for each gymkhana when registering. Any additional horses to be registered and entered by the same rider will be for a separate paid "time only" fee and will run at the bottom of their age group for 0 points. (Good way to keep a backup horse seasoned)
3. How points are received. The first-place point rider in each event receives 10 points. Second 9 points. Third 8 points. Fourth 7 points. Fifth 6 points. Sixth 5 points. Seventh 4 points. Eighth 3 points. Ninth 2 points. Tenth 1 point and so on 1 point thereafter unless a broken pattern or no time will always receive 0 points. BEST FIVE OUT OF SIX QUALIFYING POINT GYMKHANNA'S COUNT TOWARD OVERALL YEAR END POINTS.
  - a. Goat tying/un-decorating, Jackpot and Open classes do not count toward day-end or year-end points but can be awarded prizes at year-end through the Awards Committee.
4. All qualified contestants in qualifying events will receive points toward day-end prizes and year-end awards based upon their placing in their classes. Time only secondary horse riders that run at the bottom of their group do not count towards awards. Members must compete in at least four of the five events, and in at least four gymkhanas to be eligible for year-end awards.

5. Disturbing the timers or announcers will result in one warning, and if continued, will then result in a loss of day-end points.
6. Points from Gymkhana will be published on SNGC Official Website, [www.sngc-snr.info](http://www.sngc-snr.info). Or approved point platform system that is viewable by all members. Any discrepancies must be reported to the SNGC point secretary before the end of the Gymkhana Day. If no discrepancies are reported, the points will stand as published unless a complete failure was missed then the Board of Directors can review.
7. If there is an age group that only has one qualified rider, the rider will only receive the overall award and will not be given individual event awards.

## **AGE DIVISIONS**

**7 AND UNDER  
8 THROUGH 10  
11 THROUGH 13  
14 THROUGH 18  
19 AND OVER**

**(AGE IS DETERMINED BY YOUR "AGE" AS OF THE FIRST GYMKHANA May 6th 2023)**

## **DAY-END AWARDS**

1. Prizes will be given in each class for the first through sixth places. The Awards Committee will designate the prizes for each Gymkhana.
2. Points are awarded in each qualified event point class, unless you receive a no-time. A high point day-end champion and reserve champion will be determined in each of the age groups, by totaling all the event point classes with a qualified rider. To be eligible for champion and Reserve Champion, the rider must compete in at least four out of the five event point classes. Appropriately paid and qualified riders all compete for day end awards in each age group. Members are the only riders that can qualify for year-end awards.
  - a. Classes not eligible for day-end awards are Jackpots, Open, Goat Tying, Goat Undecorating, and Time Only riders.

## **YEAR-END AWARDS**

1. Awards will be organized, set-up, and issued through the Awards Committee. To qualify members will compete in at least (4) Gymkhanas and at least (4) of the (5) point classes

in each Gymkhana. Awards will only be given to members who fulfill all their required membership obligations.

2. Individual class awards will be awarded to all members who place in their age groups. To be eligible for an individual class award, you must have competed in the class at least four times during the season.
3. A Champion and Reserve Champion award for each age group will be given based on the highest and second highest points of a qualified rider throughout the year.
4. The most improved rider award will be awarded at the end of the year. This award will be given to the rider who has been nominated and voted upon as the most improved rider, improving from the first Gymkhana to the last Gymkhana of the season. Improvement of the rider's ability to control and make the horse perform at its best is the most important qualification of this award. The contestants make nominations and Directors will vote on all nominations. **SOLICITING MEMBERS FOR VOTES WILL RESULT IN DISQUALIFICATION.**
5. Most improved Horse. This horse has greatly improved his/her performance and times throughout the Gymkhanas. The Directors will vote on all nominations. **SOLICITING MEMBERS FOR VOTES WILL RESULT IN DISQUALIFICATION.**
6. SNGC Junior and Senior Sportsmanship awards will be given at the end of the year. This award will be nominated by members and voted on by the membership. Only participants are eligible. Good sportsmanship consists of always helping others, cheering your competitors on, congratulating winners and losers for good runs and always having a cheerful disposition. The Junior Award is for those 17 and under and the Senior Award is for those 18 and over. **SOLICITING MEMBERS FOR VOTES WILL RESULT IN DISQUALIFICATION.**
7. Fastest and Reserve fastest times will be awarded to the riders of said times without bias to the amount of fastest or reserve fastest times they hold.

## **CLASSES**

**Regular Classes** – The regular classes at each Gymkhana shall consist of Barrels, Poles, Bi-rangle, Figure 8, and Revolving. Regular classes will be at every Gymkhana.

**Revolving Classes** – At each Gymkhana, there will be one revolving event chosen by the board.

**Goat Classes** – When stock is available, goat tying and goat undecorating will be offered.



## **Goat Tying Rules:**

1. Time Limit: One Minute
2. The starting line will be one hundred (100) feet from the tethering stake.
3. The contestant leaves the score line with a running start, races to the goat tethered on a 10' rope, dismounts, throws the goat by hand and crosses any three feet for the tie.
  - a. Contestant may go down the rope.
  - b. If a goat is down, it must be brought to its feet and then thrown.
  - c. Piggie string or leather thong, or rope may be used to tie: no other type of material will be permitted.
  - d. Goats cannot be dropped from shoulder height to render them breathless and immobile.
  - e. Unusual roughness in handling the goat will disqualify the contestant.
  - f. Contestants will be given a 10-second penalty if horse touches goat or tether rope before or during dismounting.
  - g. The goat must be held (by official) facing the start line, at furthest point away from the contestant and must be released as starting flag drops.
4. When the tie is completed, the contestant signals time by throwing both hands in the air.
5. The tie must hold for five (5) seconds after the contestant has cleared the goat.
  - A. Contestants cannot touch the tie or goat after signaling a complete tie.
  - B. If tie comes loose or if the goat gets to its feet before time has been ruled fair, contestants will be marked no time.
  - C. If a goat breaks away because of faulty equipment the contestant will be given a re-run at the end of the event.
6. The event Director will determine goat changes.
7. No distracting goat with movement or sound or disqualification will occur.

## **Goat Undecorating:**

1. Contestant must be in the 0-7 age group
  - a. Contestants may have help in dismounting, but helpers may not touch goat or goat rope, or the contestant will be disqualified.
2. All goat-tying rules will apply, except the goat will be undecorated instead of tied.
  - a. Goat must have a bright colored ribbon tied to its tail.
  - b. Contestants must remove all the ribbon from the goat's tail and throw their hands into the air to stop time.

## GYMKHANA PATTERNS

If a contestant does not understand the patterns, it is their responsibility to review or ask a member before they make their run.

### POLE BENDING

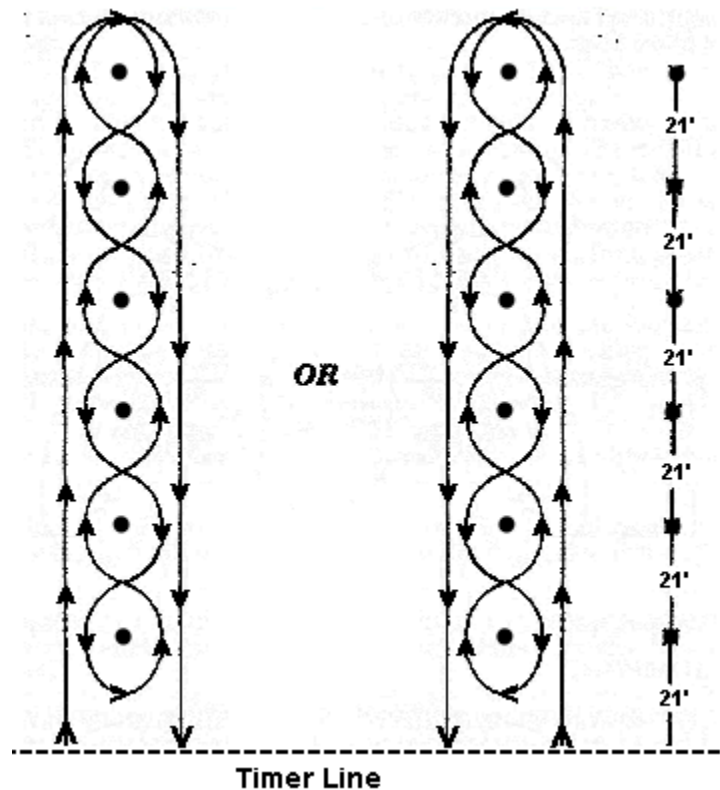

Run through the starting line, run along either side of the poles to the last pole, turn around the last pole, pass successive poles on alternate sides, turn around the last pole and race back to the starting line. Spacing of poles is 21' apart and the start finish is 21' to the first pole.

## CLOVERLEAF BARREL RACE

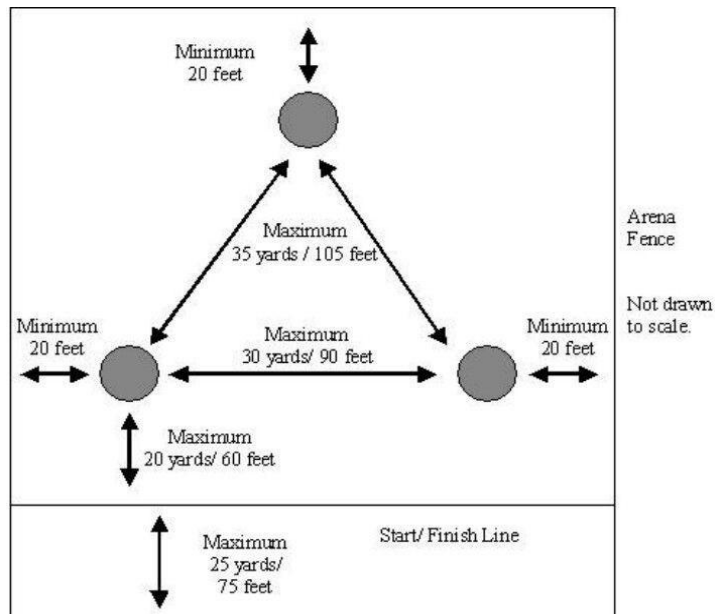
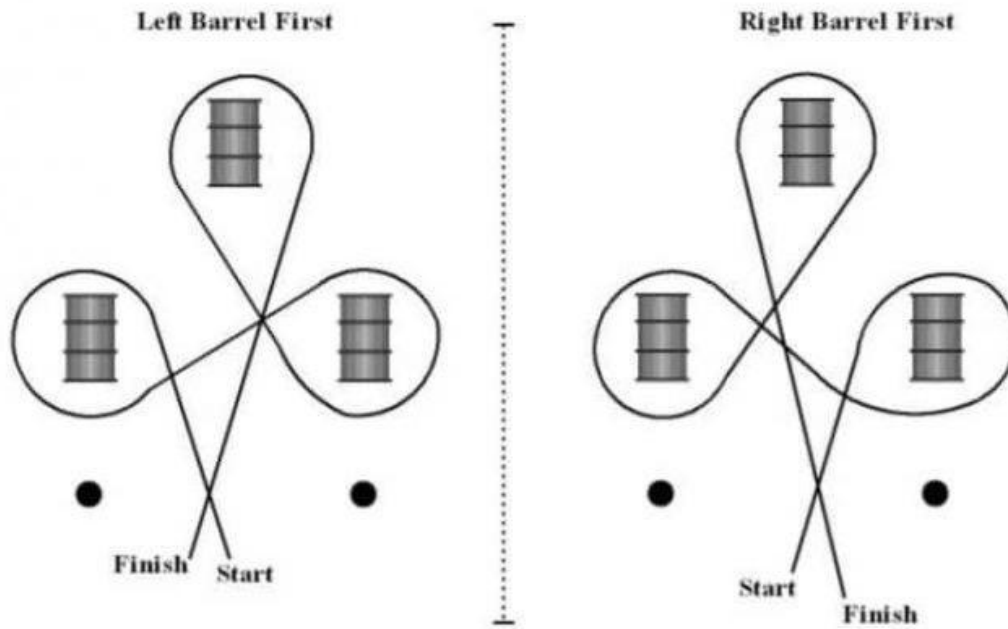

Cross start/finish line may start on either side right or left barrel. When starting on the right barrel, there will be one right turn around the barrel and two left turns. When starting on the left barrel, there will be one left turn and two right turns around the barrels. When completing the third barrel, run back through the start/finish line.

## FIGURE 8 STAKE RACE

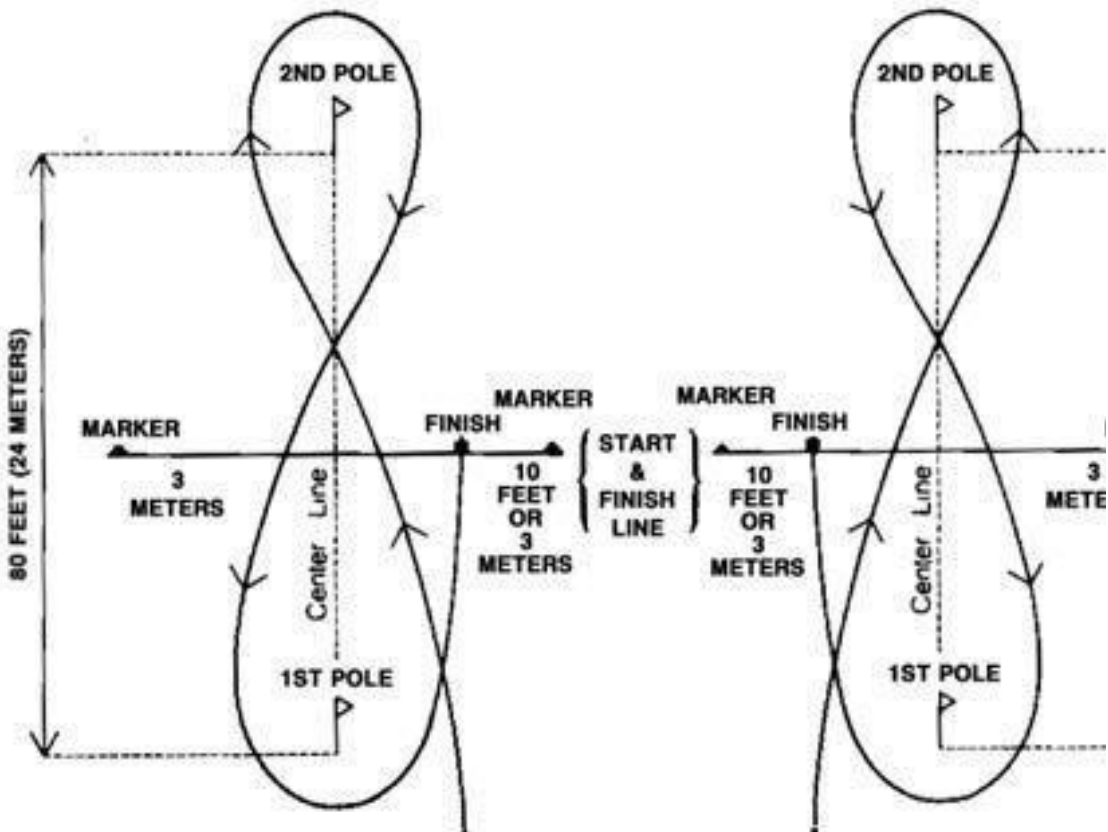

\*\*\* Above Example only\*\*\*Exact Distances may vary. We currently use 20 ft wide markers and 125 ft pole to pole

Riders must make one right and one left turn around the poles or vice versa. Contestant must cross and complete the eight within the markers to receive a time. There are two legal patterns for this event however we use this one which is customary to our local area junior rodeos.

# Birangle

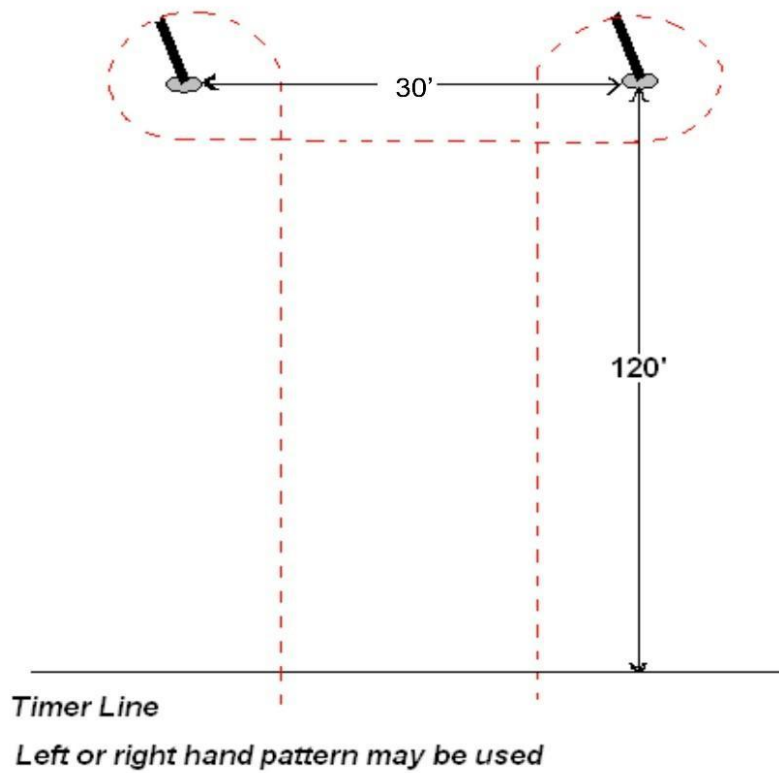

\*\*\*Above Example only\*\*\* Distances may vary. We currently use 75ft and 37.5ft

Run through the timing line, turn poles in the same direction either left or right. Pass back through the timing line.

## TWO BARREL COWHORSE

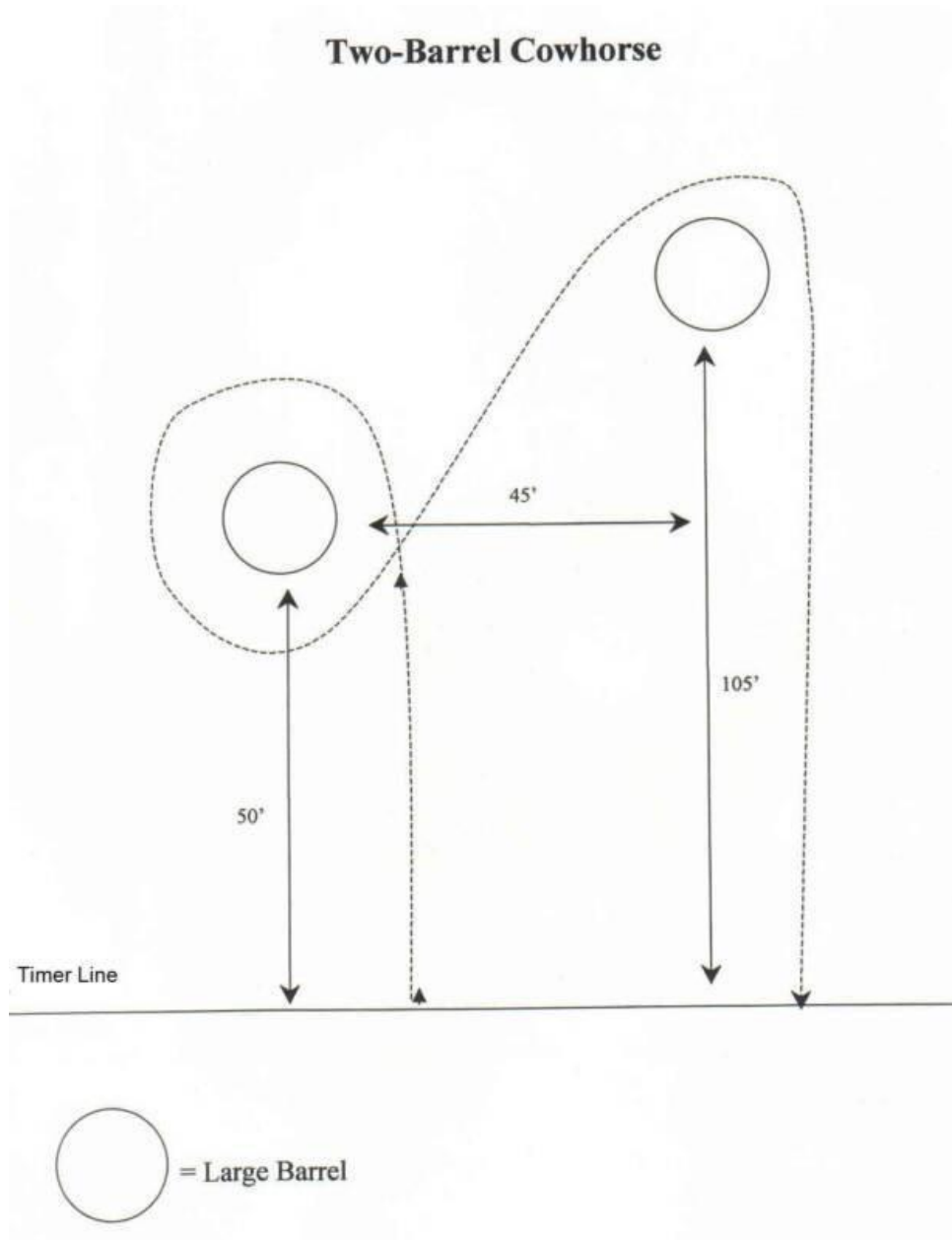

Go across the timer line and go on inside of left barrel go around and then to the outside of far barrel and back to the timer line.

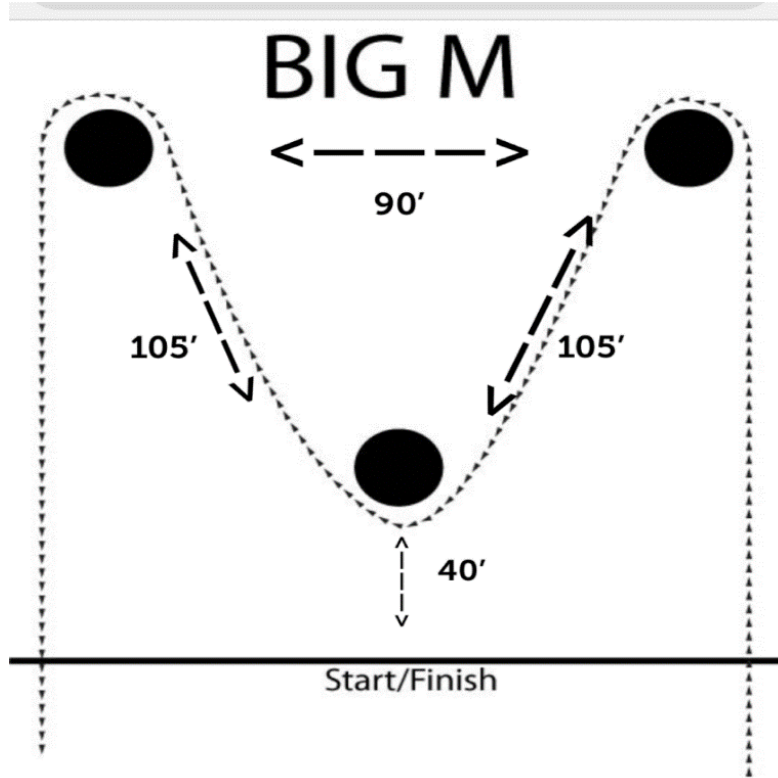

You can go either to the far right or far left barrel first, make and M with all 3 barrels.

## TURN & BURN

### Turn & Burn

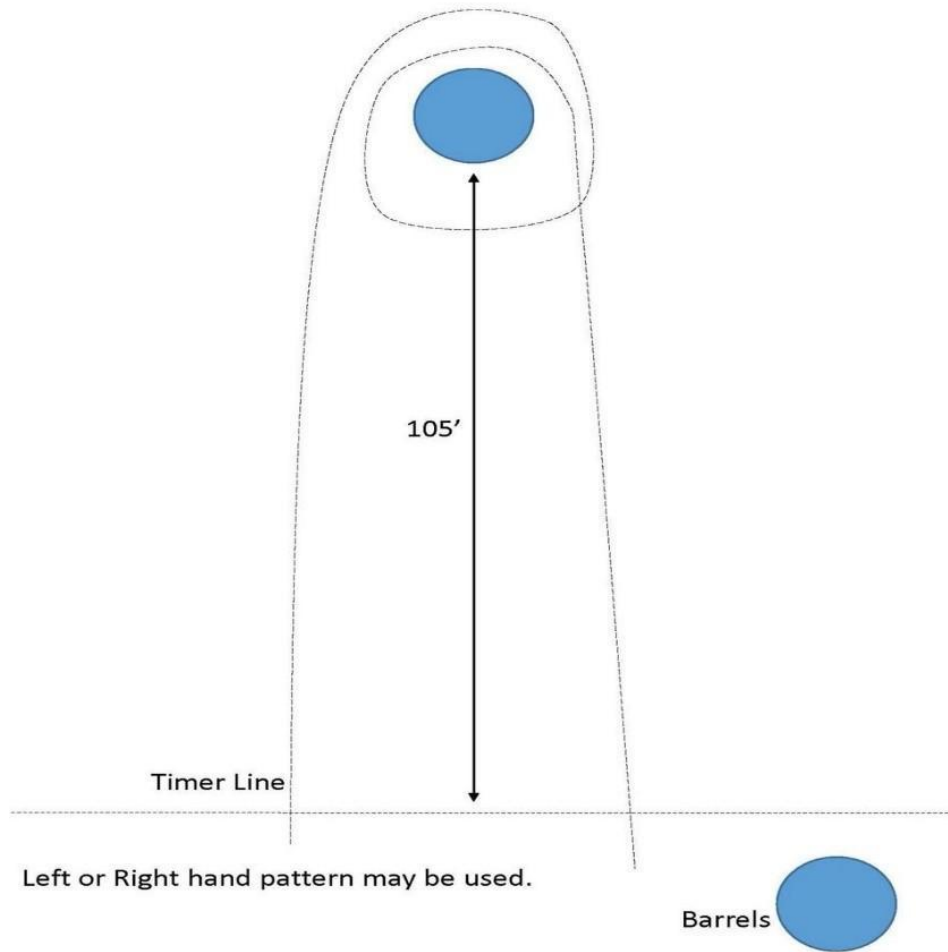

You may to the left or right make a full circle around the barrel and back across the timer.



# BIG T

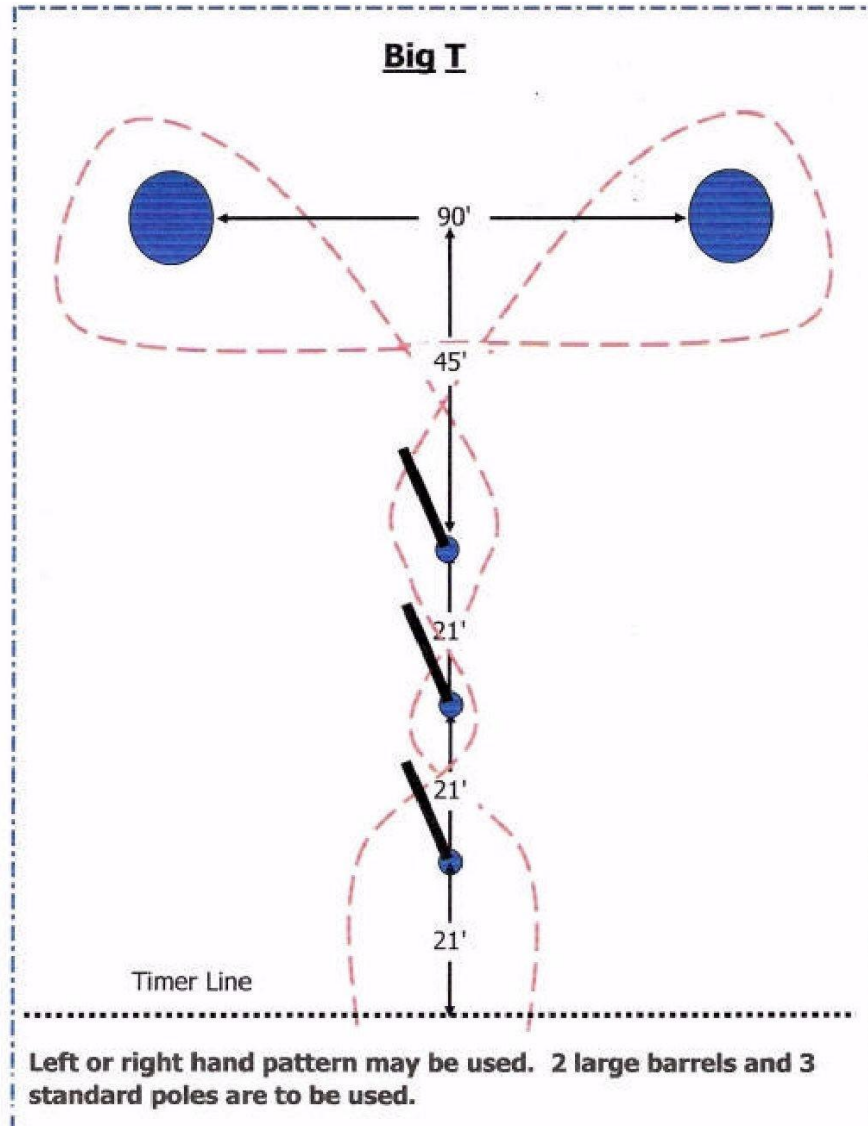

## SPEED BARRELS

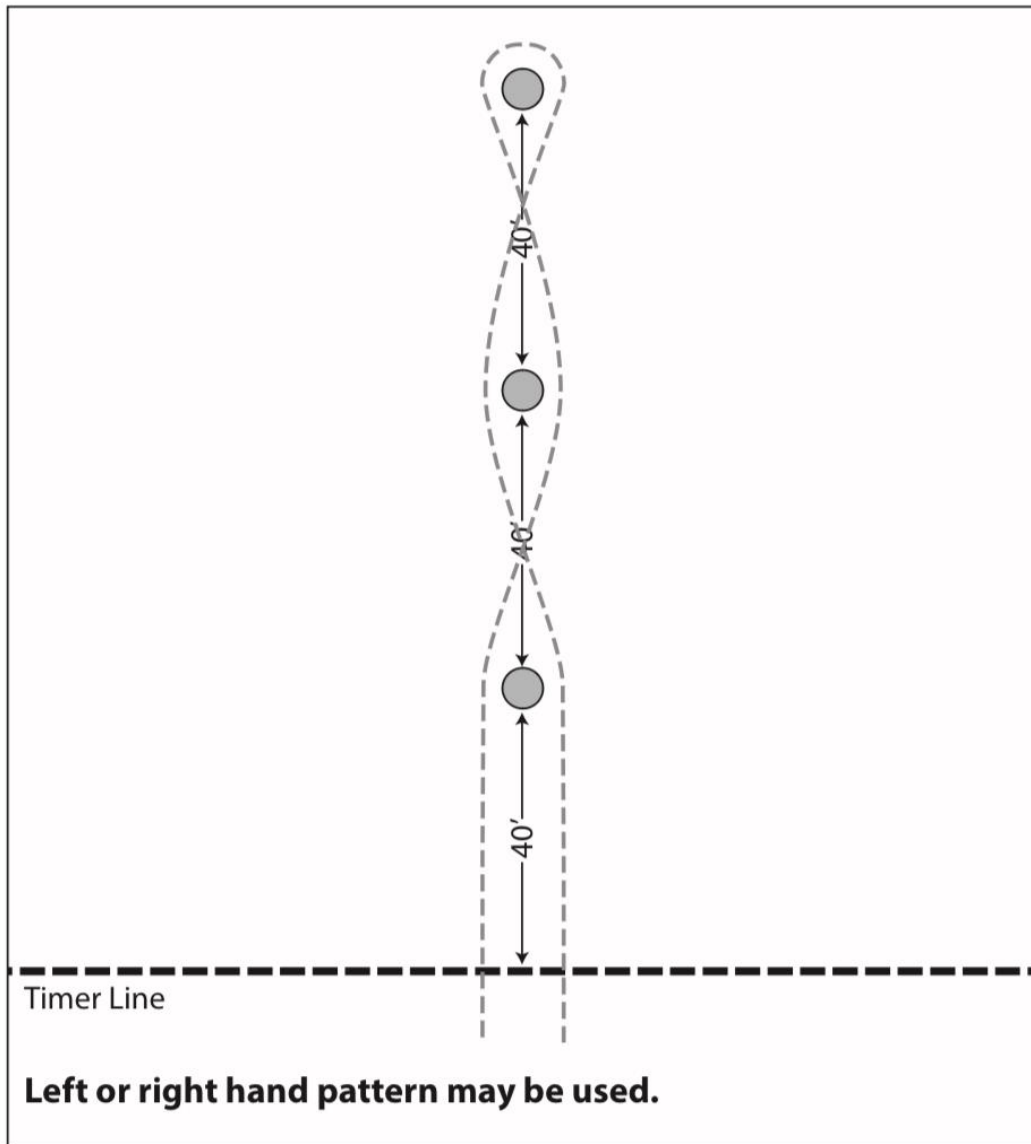

The rider crosses the start/finish line, passes barrel 1, weaves the remaining barrels until he reaches barrel 3. The rider executes a turnaround barrel 3 and then weaves back through the barrels until he crosses the start/finish line. Riders may run either right or left hand patterns.

## Single Stake

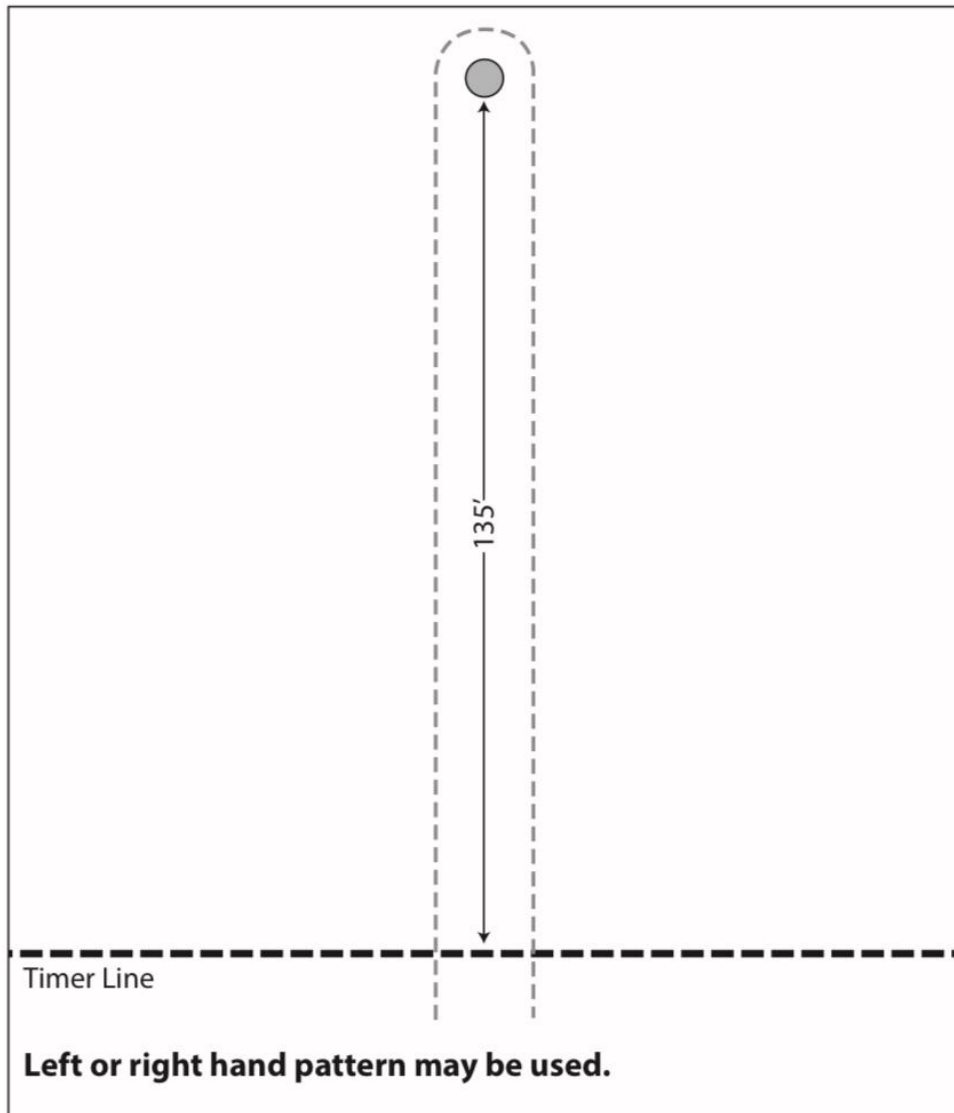

Go through the timing line to pole/barrel, turn pole/barrel (in either direction), and return across the timing line, Rider may run either right or left hand pattern.

## CHECK LIST

Please return the following forms at Play-Day or prior to the first Gymkhana. Remember...you will not accumulate points until you have paid your membership fee and turned in the necessary forms:

- Signed Membership Form
- Signed Membership Rules
- Release Form
- Copy of birth certificate for those under 18
- Participant Wish List
- Award Nominations (Most improved Rider and Most Improved Horse. Senior and Junior sportsmanship)
- Committee Form

Forms can be downloaded at: [www.sngc-snr.info](http://www.sngc-snr.info) You can print, sign and return to any board member or email to [snjrandsngc@gmail.com](mailto:snjrandsngc@gmail.com)

You are always welcome to mail any of the above forms to:

SNGC  
PO Box 60674  
Reno, NV 89506

At any point in the season you have questions, please do not hesitate to contact any one of the Officers or Directors. They will be happy to offer their assistance.

## **INDIVIDUAL**

### **Membership Information/Application**

There are three types of individual memberships available: General Individual, General non-competing and Associate Individual Membership. To maintain your General Membership status, you must fulfill your volunteer requirements as outlined in the Membership Information section of this Application. (Volunteer/Fundraising Requirements must be met by the last gymkhana or ALL General Memberships will be converted to an "Associate" Membership and the difference in fees will be due and payable immediately. Any outstanding fees not paid will cause you to become a Member NOT in good standing and will make you ineligible for Year End Awards.)

*Please Check the Membership you wish to select:*

**General Individual Membership (\$75)** \_\_\_\_\_

PLUS 15 raffle ticket sales or donation of equivalent value and 85 volunteer points

**General non-Competing (\$50)** \_\_\_\_\_

PLUS 15 raffle ticket sales or donation of equivalent value and 85 volunteer points

**Associate Individual Membership (\$350)** \_\_\_\_\_

(No Volunteer/Fundraising Jobs Required/No Voting Privileges)

Individual Name: \_\_\_\_\_

Address: \_\_\_\_\_

City: \_\_\_\_\_ State: \_\_\_\_\_ Zip: \_\_\_\_\_

Phone Number (    ) \_\_\_\_\_ DOB: \_\_\_\_\_

Email Address: \_\_\_\_\_

I agree to read and abide by the SNGC/SNJR rules; I also acknowledge receiving my MEMBER INFORMATION PACKET.

\_\_\_\_\_  
Signature

\_\_\_\_\_  
Date

BIRTH CERTIFICATE MUST BE TURNED IN WITH PACKET

Office Use Only: Amt Paid \_\_\_\_\_ Cash \_\_\_\_\_ Check \_\_\_\_\_ Date \_\_\_\_\_ Rec'd By: \_\_\_\_\_

## **FAMILY**

There are three types of FAMILY memberships available: General Family, General Family (1) child, (1) Non-Competing and Associate Family Membership. To maintain your General Membership status, you must fulfill your volunteer requirements as outlined in the Membership Information section of this packet. (Volunteer/Fundraising Requirements must be met by the last gymkhana or ALL General Memberships will be converted to an "Associate" Memberships and the difference in fees will be due and payable immediately. Any outstanding fees not paid will cause you to become a Member NOT in good standing and will make you ineligible for Year End Awards.)

### **General Family Membership (\$150) \_\_\_\_\_**

*(Family means IMMEDIATE family in the same current household. If the child is 18 or older but still in school, he or she is covered under this Family membership).* PLUS 25 raffle ticket sales or donation of equivalent value and volunteer time.

### **General Family (1) Child (1) Non-Competing Membership (\$125) \_\_\_\_\_**

*(Family means IMMEDIATE family in the same current household. If the child is 18 or older but still in school, he or she is covered under this Family membership).* This membership is for single families with one competing child. PLUS 25 raffle ticket sales or donation of equivalent value and volunteer time.

### **Associate Family Membership (\$525) \_\_\_\_\_**

(No Volunteer/Fundraising Jobs Required/No Voting Privileges)

Names: \_\_\_\_\_

Address: \_\_\_\_\_

City: \_\_\_\_\_ State: \_\_\_\_\_ Zip: \_\_\_\_\_

Phone Number (    ) \_\_\_\_\_ Email Address: \_\_\_\_\_

Contestant Name: \_\_\_\_\_ DOB: \_\_\_\_\_

Contestant Name: \_\_\_\_\_ DOB: \_\_\_\_\_

Contestant Name: \_\_\_\_\_ DOB: \_\_\_\_\_

I/we agree to read and abide by the SNGC/SNJR rules, I also acknowledge receiving my MEMBER INFORMATION PACKET.

\_\_\_\_\_  
Signatures

\_\_\_\_\_  
Date

BIRTH CERTIFICATE MUST BE TURNED IN WITH UNDER 18 CONTESTANTS

Office Use Only:

Amt Paid \_\_\_\_\_ Cash \_\_\_\_\_ Check \_\_\_\_\_ Date \_\_\_\_\_ Rec'd By: \_\_\_\_\_

# **Sierra Nevada Junior Rodeo and Gymkhana Club Assumption of Risk, Waiver and Release of liability, and Indemnification Agreement**

This document shall be enforced to the greatest extent permitted by law. If any clause of this document conflicts with applicable law, only that clause will be null and void, but the remainder shall stay in full force and effect. Should a contestant, parent, or legal guardian of a minor contestant file a lawsuit in breach of this document agree to pay all attorney fees, court costs, and other costs incurred by Sierra Nevada Junior Rodeo/Gymkhana Club.

Herein, these terms listed below will be referred or written:

- 1. Sierra Nevada Junior Rodeo/Gymkhana Club----SNJR/SNGC**
- 2. Contestant--- Will include the minor contestant's parent or legal guardian.**
- 3. Sierra Nevada Junior Rodeo/Gymkhana Club events----Event**

Contestant agrees to the following:

- 1. Inherent Risks of Equine Activities/Assumption of Risks: Contestant acknowledges that there are numerous inherent risks of equine activities, whether preparing for, entering, attending, participating in, or leaving the Events. This inherent risks include these dangers and conditions which are an integral part of equine activities, including but not limited to:**
  - a. the propensity of an equine or other animals to behave in ways that may result in injury, harm or death to persons on or around them**
  - b. the unpredictability of the equines' reaction to such things as sounds, sudden movements, and unfamiliar objects, persons, or other animals;**
  - c. certain hazards such as surface or subsurface conditions:**
  - d. collisions with other animals or objects;**
  - e. the potential of a participant or other contestant to act in a negligent manner that may contribute to injury to the participant, contestant, or others, such as failing to maintain control over the equine or not act within his or hers ability**
  - f. the breakage or failure of tack or other equipment:**
  - g. the potential that an equine or animal may suffer an injury or lose its footing or balance resulting in a fall or other movement that causes injury or harm to the rider or other persons or animals in the vicinity.**
- 2. Contestant is not relying on SNJR/SNGC to list all possible inherent risks or all risks of participating in equine events.**
- 3. Waiver and Release of Liability: With full knowledge and appreciation of these inherent risks of equine activities, Contestant freely and voluntarily assumes the**

risks of the equine activities involved in any aspect of the Event. In this connection, Contestant so voluntarily agrees to waive any and all rights to sue and hereby releases SNJR/SNGC from all liability, loss, claims, or actions for injury, death, expenses, or damage to person or property resulting from the inherent risks of the event or resulting from any action or inaction of SNJR/SNGC. This waiver and release shall be effective even if the injury, death, or damage to a person or property is caused by or contributed to by actions of failure to Contestant nor contestants representatives shall make any claim against, maintain an action against, or recover from the Event or its sponsors, promoters, producers, directors, officers, employees, agents, volunteers, representatives, designated officials, or other acting on their behalf for injury, loss, damage or death of the Contestant or to the contestant's horse or personal property. (Regardless of whether the SNJR/SNGC was negligent or somehow violated an applicable law pertaining to equine activities.)

4. **Indemnification:** contestant, or parent or legal guardians of the undersigned minor, hereby agrees to indemnify and hold harmless the SNJR/SNGC from any liability, claim, loss, action or expenses asserted or incurred by the Event for damages arising out of the actions or inactions of the Contestant and Contestant's employees, agents, representatives, trainers, animals, independent contractors, or other acting on their behalf. The term "expenses" shall include, but not limited to, attorney fees, court costs, investigations costs, and other expenses incurred in the defense of any matter asserted which may be covered by this indemnification provision.
5. **Compliance with the Sierra Nevada Gymkhana Club Rule Book:** Contestants understands and agrees that entry to any sanctioned Events shall constitute an agreement that the contestant, (including the horse owner, lessee, trainer, coach, rider, and the horse), shall be subject to the Sierra Nevada Gymkhana Club rule Book. Any disputes between the contestant and Sierra Nevada Gymkhana Club in regard to the Event shall be governed by the Rule Book specific to the Event. A Contestant's sole and complete remedy for any dispute is an appeal to the proper appellate body, committee, as identified for such disputes in the Sierra Nevada Gymkhana Club Rule Book.
6. **Use of Photographs or Videos:** Contestant hereby irrevocably grants full permission for the SNJR/SNGC, to use and publish photographs, videos or movies taken of the Contestant at the Event, even if such use and publication is for commercial or promotional purposes.



**2023 Sierra Nevada Junior Rodeo and Gymkhana Inc Acknowledgment Form**

I have read the entire 2023 SNJR/SNGC Membership packet including but not limited to, Assumption of Risk, Waiver and Release of Liability and Indemnification pertaining to the 2023 SNJR/SNGC Membership Packet. I am the contestant(s), and or the parent or the legal guardian of the contestant(s) freely and voluntarily seeking participation at an SNJR/SNGC Event. Contestants appreciate and assume all risks inherent in and or at any SNJR/SNGC event. I (we) all understand this document is a release of claims and agree to be fully bound by its terms.

Contestant Name \_\_\_\_\_ Age Group: \_\_\_\_\_

Contestant Name \_\_\_\_\_ Age Group: \_\_\_\_\_

Contestant Name \_\_\_\_\_ Age Group: \_\_\_\_\_

Contestant Name \_\_\_\_\_ Age Group: \_\_\_\_\_

Release: I \_\_\_\_\_, the contestant, the contestant's parent or legal guardian, do hereby release the Sierra Nevada Junior Rodeo/Gymkhana Club, or its sponsors, promoters, directors, officers, employees, agents, volunteers, representatives, designated officials. Or others, acting on their behalf from any and all responsibility and liability for any and all injuries or disablements of any kind whatsoever, suffered or inflicted at any Sierra Nevada Junior Rodeo/Sierra Nevada Gymkhana Club event. I have the Assumption Of Risk, Waiver and Release of Liability, And Indemnification Agreement, I understand it and agree to be fully bound by its terms.

Print: \_\_\_\_\_ Date: \_\_\_\_\_  
(Parent/Guardian/Contestant/Rider 18 or older)

Sign: \_\_\_\_\_ Date: \_\_\_\_\_  
(Parent/Guardian/Contestant/Rider 18 or older)

**2023 SNGC General Rules**

I, the undersigned, acknowledge receipt of the written 2023 SNGC General Rules. By signing below, I certify that I have read and understand the contents of these General Rules. Further, I agree to abide by these rules as written. I understand that failure to abide by these general rules could result in a forfeiture of any points earned, disqualification or termination of my membership (*where applicable*).

Please print Member name and Sign. If Member is under 18-years old, both member and parent/legal guardian **must** sign.

Please Print Name then Sign.

Individual/Family Name: \_\_\_\_\_

Contestant \_\_\_\_\_

SIGNATURE \_\_\_\_\_

Contestant \_\_\_\_\_

SIGNATURE \_\_\_\_\_

Contestant \_\_\_\_\_

SIGNATURE \_\_\_\_\_

Contestant \_\_\_\_\_

SIGNATURE \_\_\_\_\_

GUARDIAN \_\_\_\_\_

This form is part of your Membership Package, and as such, must be completed and turned in before points can begin to be accumulated.

## **RAFFLE TICKET SALES**

THE SALE OF RAFFLE TICKETS HAS HISTORICALLY BEEN A SUCCESSFUL FUNDRAISING EVENT IN WHICH THE FUNDS GENERATED FOR SALES ARE USED TOWARD AWARDS FOR JUNIOR RODEO AND GYMKHANA END OF YEAR AWARDS. EACH NON-COMPETING MEMBER WILL BE GIVEN 10 TICKETS TO SELL, INDIVIDUAL MEMBERS WILL BE GIVEN 15 TICKETS TO SELL AND FAMILY MEMBERSHIP WILL BE GIVEN 25 TICKETS TO SELL. ANY UNSOLD TICKETS AND MONEY MUST BE TURNED IN AND ACCOUNTED FOR AT END OF SALES.

NAME \_\_\_\_\_

EMAIL \_\_\_\_\_

PHONE \_\_\_\_\_

CIRCLE MEMBERSHIP TYPE:

NON-COMPETING

INDIVIDUAL

FAMILY

# 2023 PLAQUE ORDER FORM

Photo plate plaques available. Please check one. If you choose yes to ordering a plaque, please complete and turn in.

**PLATE PLAQUE** YES \_\_\_\_\_ NO \_\_\_\_\_  
(Fees will be assessed at the time the plaques are ordered as prices fluctuate.)

## Please Print Clearly

Contestant Name: \_\_\_\_\_

Age Group: \_\_\_\_\_

**Office Use Only:**

Amt Paid \_\_\_\_\_ Cash \_\_\_\_\_ Check \_\_\_\_\_ Date \_\_\_\_\_ Rec'd By: \_\_\_\_\_

Date plaque ordered \_\_\_\_\_

Date plaque given to contestant/contestant representative \_\_\_\_\_

## **VOLUNTEER/COMMITTEE INTEREST FORM**

Following are the 2023 committees. Be sure to number the boxes below for the committees you and your family members are interested in. 1 thru 8 with 1 being most interested in. Keep in mind you may need to participate in several committees to earn enough volunteer time. Efforts will be made to allow the opportunity for you to participate in your preferred committees, however there are some committees needing more support than others. You may not be placed in your preferred committees due to the size of committee needs. Thank you for your patience and understanding that support is needed in many aspects to make the organization run smoothly. If you have strengths and/or knowledge in areas that the organization could be using, let us know! Additional details on volunteer committees can be found on pages 5-7

**Membership Name:** \_\_\_\_\_

**Volunteer Name:** \_\_\_\_\_ **Phone Number** \_\_\_\_\_  
**email** \_\_\_\_\_

**Volunteer Name:** \_\_\_\_\_ **Phone Number** \_\_\_\_\_  
**email** \_\_\_\_\_

**Volunteer Name:** \_\_\_\_\_ **Phone Number** \_\_\_\_\_  
**email** \_\_\_\_\_

- Membership, Points, and Rules Committee**  
Preference number 1-8 \_\_\_\_\_
- Fundraising, Public Relations and Advertising Committee**  
Preference number 1-8 \_\_\_\_\_
- Equipment, Security and Grounds Committee**  
Preference number 1-8 \_\_\_\_\_
- Event Committee**  
Preference number 1-8 \_\_\_\_\_
- Goat Committee**  
Preference number 1-8 \_\_\_\_\_
- Snack Bar Committee**  
Preference number 1-8 \_\_\_\_\_
- Queen/Flag Committee**  
Preference number 1-8 \_\_\_\_\_
- Jr Rodeo Committee**  
Preference number 1-8 \_\_\_\_\_

**All members will be expected to participate in the following:**

Raffle Ticket Sales  
Silent Auctions  
Raffle Donations  
Sponsors and Donors  
Jackpots

Volunteering at other Rodeos or Events

Please add any additional experience that you have that could be beneficial to the committees: